

TECHNICAL

12 mm

DETAILS

64 mm

22.6

23 mm

13 mm

bicachair®

29 mm

9 2.5 21 2.5

Vista Perfil

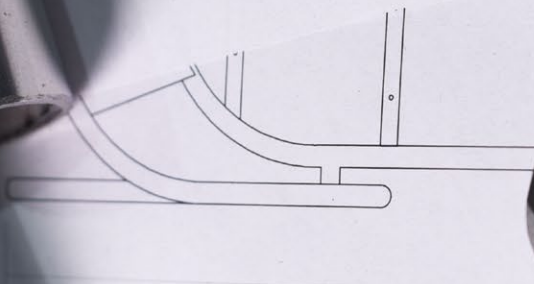
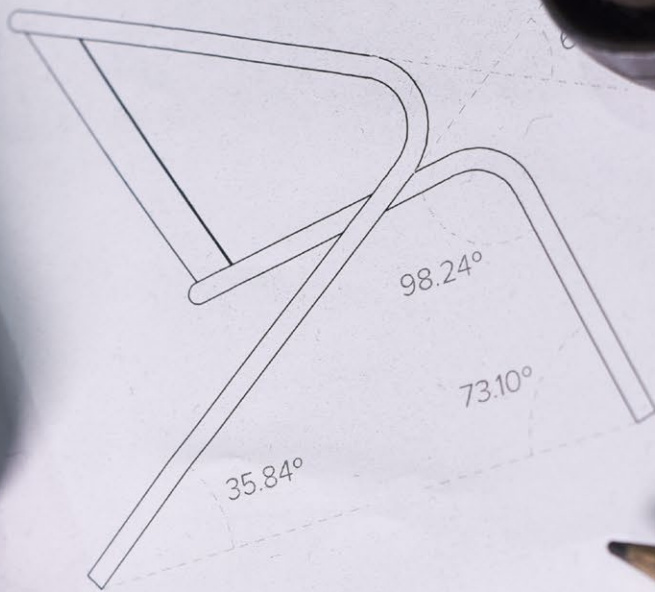

82

Vista Perfil

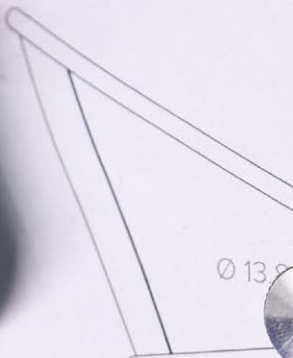

$\varnothing 13.8$



BICA chair structures are mostly made of round steel tube, 1.5 mm thick, recycled and recyclable.

The entire process of structure degreasing is done without the use of water or acids, but with steel grit pickling. Besides having great ecological value, this action allows a greater efficiency in the adherence of the painting, due to its rough finishing.

In the case of outdoor material, the next process is the casting of zinc with the metal itself, by means of projection, also without the use of solvents or acids. In any of these finishes, the final texture allows a high adherence to the painting.

The final finishing is done through a powder painting process, by electrodeposition, followed by baking in an oven at 210 degrees to transmit hardness and resistance. In order to keep the colors alive, we use finishes with UV protection, which makes you enjoy your chair for a longer time.

Our upholstery has the highest quality standards and certifications, both for personal and professional use. The natural woods applied are FSC (Forest Stewardship Council) and finished with natural oils. We use 316 Stainless Steel screws to fix them.

The following dimensions may suffer minor changes.

BICAchair- Available Options



Seat
Upholstery



Seat & Back
Upholstery



Seat
Wood Ipé

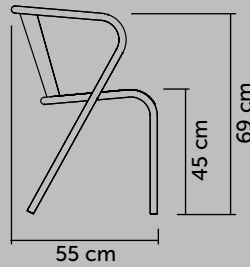
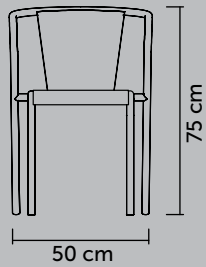
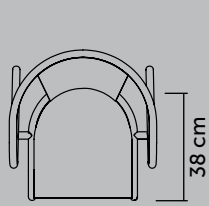

Upholstered

7 kg

Ipé Wood

7,5 kg

Available in all collections.

Structure: Round steel tube, 25mm x 1.5mm thick; Metal back plate, 1.5mm thick

Upholstery: 12mm plywood FSC with high density foam

IPÉ wood slabs: 20mm Brazilian origin Ipé wood with natural oil

BICAchair XL - Available Options



Seat
Upholstery



Seat & Back
Upholstery



Seat
Wood Ipé

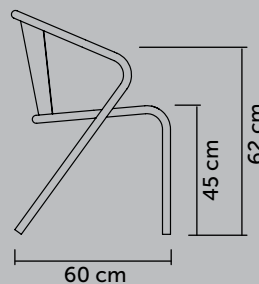
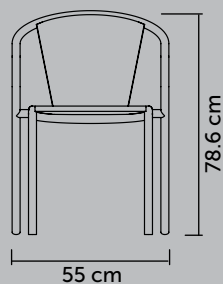
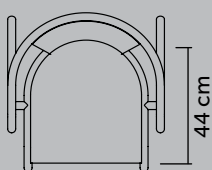

Upholstered

8,3 kg

Ipé Wood

9,3 kg

Available in all collections.

Structure: Round steel tube, 30mm x 1.5mm thick; Metal back plate, 1.5mm thick

Upholstery: 12mm plywood FSC with high density foam

IPÉ wood slabs: 20mm Brazilian origin Ipé wood with natural oil

BICAlounge - Available Options



Seat Upholstery

Seat & Back Upholstery

Seat Wood Ipê

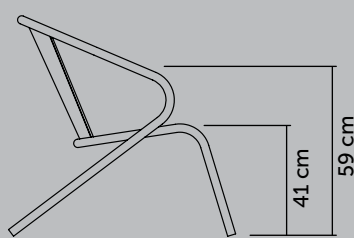
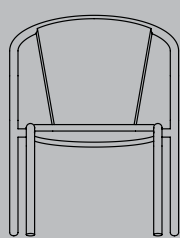
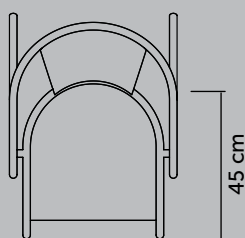

Upholstered

11,3 kg

Ipê Wood

12,1 kg

62 cm

82 cm

59 cm

41 cm

Available in all collections.

Structure: Round steel tube, 30mm x 1.5mm thick; Metal back plate, 1.5mm thick

Upholstery: 12mm plywood FSC with high density foam

IPÊ wood slabs: 20mm Brazilian origin Ipê wood with natural oil

BICAottoman - Available Options



Upholstery

Wood Ipê

Upholstery

Wood Ipê

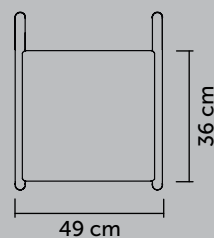
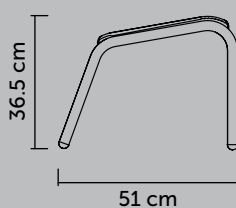
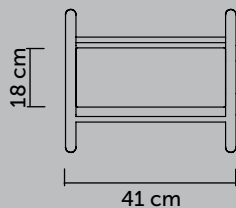
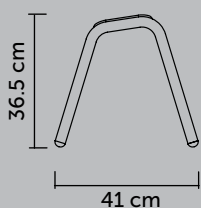

Upholstered

3,9 kg

Ipê Wood

4,6 kg

Upholstered

4,3 kg

Ipê Wood

6,6 kg

Available in all collections.

Structure: Round steel tube, 30mm x 1.5mm thick; Metal back plate, 1.5mm thick

Upholstery: 12mm plywood FSC with high density foam

IPÊ wood slabs: 20mm Brazilian origin Ipê wood with natural oil

BICastool - Available Options



Seat
Upholstery



Seat & Back
Upholstery



Seat
Wood Ipé

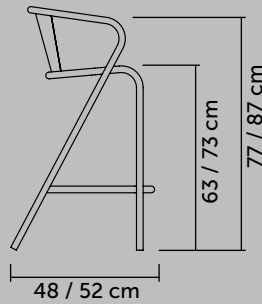
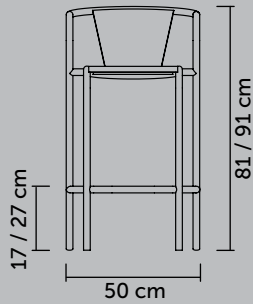
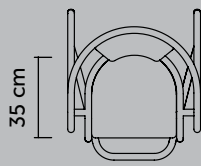

Upholstered

8,3 kg

Ipé Wood

9,2 kg

Available in all collections.

Structure: Round steel tube, 25mm x 1.5mm thick; Metal back plate, 1.5mm thick

Upholstery: 12mm plywood FSC with high density foam

IPÉ wood slabs: 20mm Brazilian origin Ipé wood with natural oil

BICatable Trio - Available Options

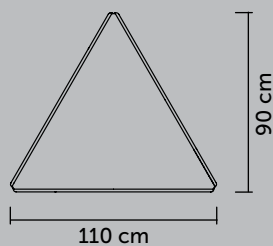
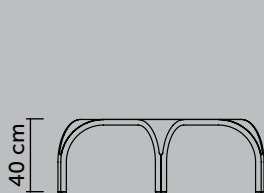

Metal

00 kg

Available in all collections.

Structure: Round steel tube, 30mm x 1.5mm thick; Metal plate, 1.5mm thick

BICAtable 3 Regular - Available Options



HPL



Veneer

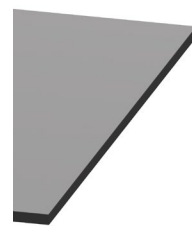

Phenolic



Metal

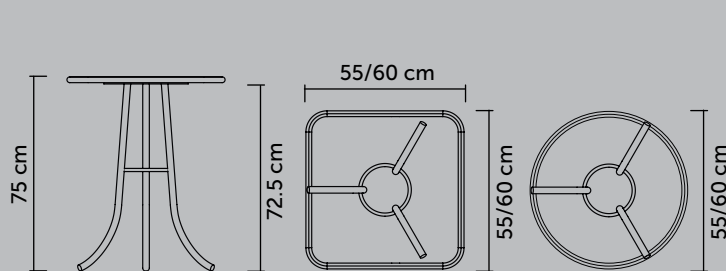

	55x55	60x60
HPL/Veneer	8 kg	8,9 kg
Phenolic	7,9 kg	8,8 kg
Metal	8,4 kg	10,2 kg

Available in all collections.

Structure: Round steel tube, 25mm x 1.5mm thick; Metal plate, 1.5mm thick

Phenolic: 12mm phenolic from EGGER or POLYREY

Veneer: 22mm Plywood + natural veneer with water-based varnish natura effect finish

HPL: 22mm Shawman-Wisa + HPL from EGGER or POLYREY

BICAtable 3 High - Available Options



HPL



Veneer

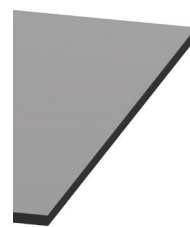

Phenolic



Metal

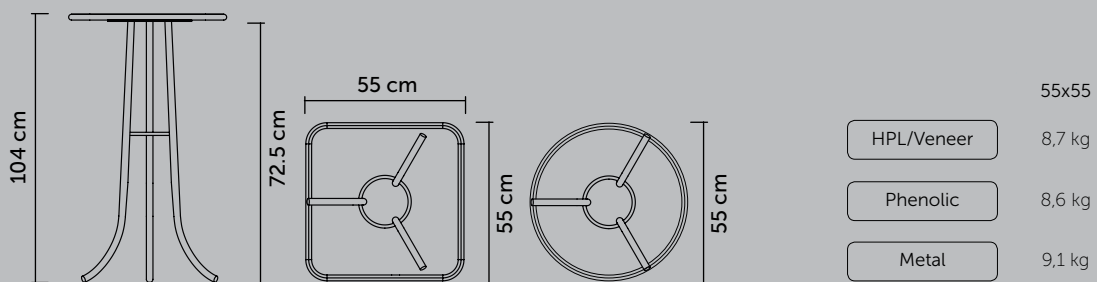

Available in all collections.

Structure: Round steel tube, 25mm x 1.5mm thick; Metal plate, 1.5mm thick

Phenolic: 12mm phenolic from EGGER or POLYREY

Veneer: 22mm Plywood + natural veneer with water-based varnish natura effect finish

HPL: 22mm Shawman-Wisa + HPL from EGGER or POLYREY

BICAtable Side - Available Options



IPE Wood



Metal

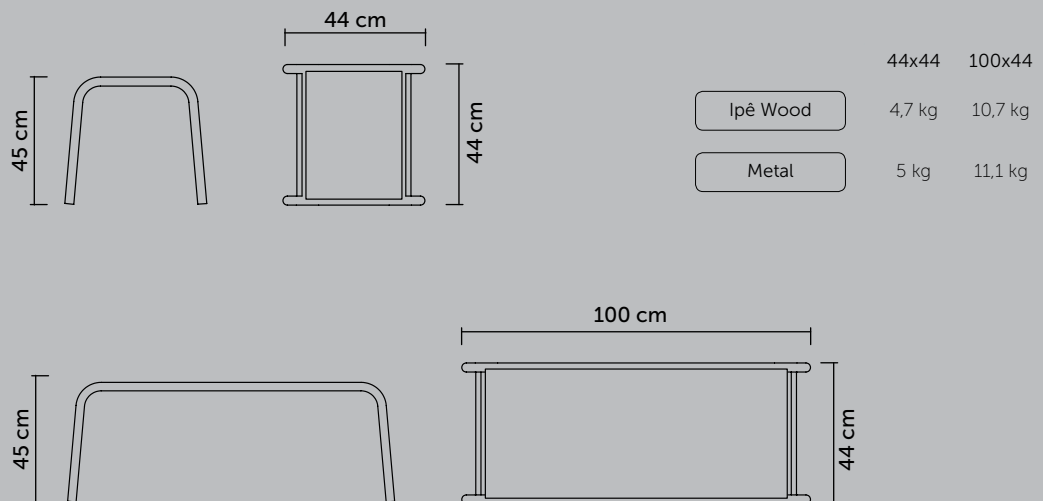

Available in all collections.

Structure: Round steel tube, 30mm x 1.5mm thick; Metal plate, 1.5mm thick
 IPÊ wood slabs: 20mm Brazilian origin Ipê wood with natural oil

BICAtable Square - Available Options



HPL



Veneer



Marble

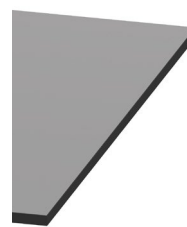

Phenolic



IPE Wood

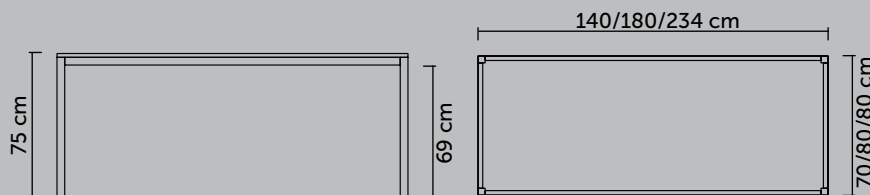
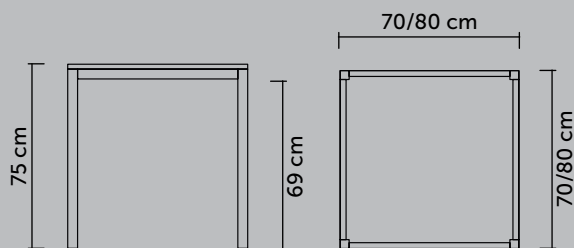

	70x70	80x80
HPL/ Veneer	13,5 kg	16,4 kg
Marble	32,6 kg	41,3 kg
Phenolic	13,4 kg	16,3 kg
Ipê Wood	15,8 kg	19,5 kg

	140x70	180x80	234x80
HPL/ Veneer	29,6 kg	39,5 kg	48,9 kg
Marble	67,7 kg	95,5 kg	123,6 kg
Phenolic	29,4 kg	39,2 kg	48,5 kg
Ipê Wood	34,2 kg	46,3 kg	58 kg

Available in all collections.

Structure: Square steel tube, 40mm x 1.5mm thick

Phenolic: 12mm phenolic from EGGER or POLYREY

Veneer: 22mm Plywood + natural veneer with water-based varnish natura effect finish

HPL: 22mm Shawman-Wisa + HPL from EGGER or POLYREY

Marble: 20 mm Natural Portuguese Marble

IPÊ wood slabs: 20mm Brazilian origin Ipê wood with natural oil

BICAtable Central High / Regular / Low - Available Options



HPL



Veneer



Marble

<p>45 cm 36 cm</p>	<p>60/70 cm 60/70 cm</p>	<p>Ø 60/70 cm</p>	<table border="1"> <tr> <td></td> <td>60x60</td> <td>70x70</td> </tr> <tr> <td>HPL/Veneer</td> <td>17,7 kg</td> <td>19,8 kg</td> </tr> <tr> <td>Marble</td> <td>31,7 kg</td> <td>38,9 kg</td> </tr> </table>			60x60	70x70	HPL/Veneer	17,7 kg	19,8 kg	Marble	31,7 kg	38,9 kg				
				60x60	70x70												
HPL/Veneer	17,7 kg	19,8 kg															
Marble	31,7 kg	38,9 kg															
<p>75 cm 36 cm</p>	<p>60/70/80 cm 60/70/80 cm</p>	<p>Ø 60/70/80 cm</p>	<table border="1"> <tr> <td></td> <td>60x60</td> <td>70x70</td> <td>80x80</td> </tr> <tr> <td>HPL/Veneer</td> <td>19 kg</td> <td>21,1 kg</td> <td>23,5 kg</td> </tr> <tr> <td>Marble</td> <td>33 kg</td> <td>40,2 kg</td> <td>48,4 kg</td> </tr> </table>				60x60	70x70	80x80	HPL/Veneer	19 kg	21,1 kg	23,5 kg	Marble	33 kg	40,2 kg	48,4 kg
				60x60	70x70	80x80											
HPL/Veneer	19 kg	21,1 kg	23,5 kg														
Marble	33 kg	40,2 kg	48,4 kg														
<p>104 cm 36 cm</p>	<p>55/60 cm 55/60 cm</p>	<p>Ø 55/60 cm</p>	<table border="1"> <tr> <td></td> <td>55x55</td> <td>60x60</td> </tr> <tr> <td>HPL/Veneer</td> <td>19,5 kg</td> <td>20,4 kg</td> </tr> <tr> <td>Marble</td> <td>30,4 kg</td> <td>34,4 kg</td> </tr> </table>			55x55	60x60	HPL/Veneer	19,5 kg	20,4 kg	Marble	30,4 kg	34,4 kg				
				55x55	60x60												
HPL/Veneer	19,5 kg	20,4 kg															
Marble	30,4 kg	34,4 kg															

Available in all INDOOR collections.

Structure: Round steel tube, 60 x 1.5mm thick; Metal plate, 10mm thick

HPL: 22mm Shawman-Wisa + HPL from EGGER or POLYREY

Veneer: 22mm Plywood + natural veneer with water-based varnish natura effect finish

Marble: 20 mm Natural Portuguese Marble

BICAtable 4 - Available Options



HPL



Veneer

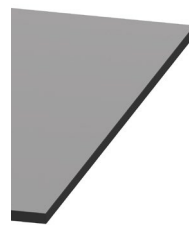

Phenolic



Metal

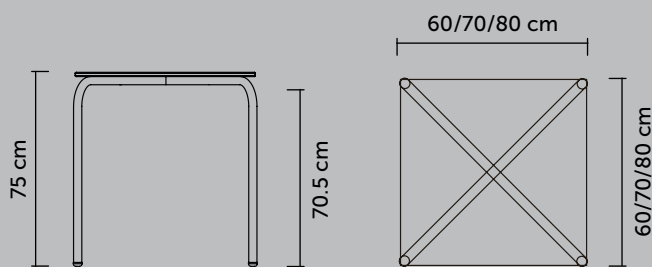

	60x60	70x70	80x80
HPL/Veneer	9,7 kg	12,2 kg	15 kg
Phenolic	9,6 kg	12,1 kg	14,9 kg
Metal	8,3 kg	10,3 kg	12,5 kg

Available in all collections.

Structure: Round steel tube, 28mm x 1.5mm thick

Phenolic: 12mm phenolic from EGGER or POLYREY

Veneer: 22mm Plywood + natural veneer with water-based varnish natura effect finish

HPL: 22mm Shawman-Wisa + HPL from EGGER or POLYREY

BICAtable Dine - Available Options



Veneer

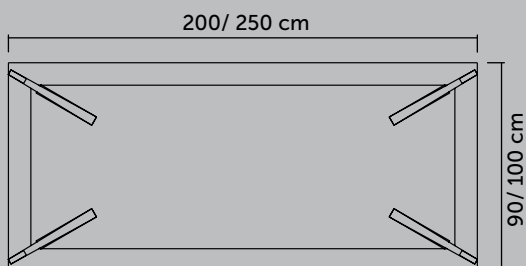
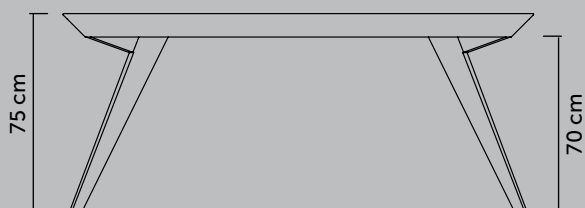

Veneer

200x90 250x100

86,8 kg 114,8 kg

Available in all INDOOR collections.

Structure: Metal plate, 1.5mm thick

Table Top: Internal reinforcement in metal structure and plywood +
natural veneer with water-based varnish natura effect finish

We are solutions
seekers. If you
don't find exactly
what you were
looking for, try us.

bicachair.

Share Moments



info@bicachair.com
www.bicachair.com

MADE IN LISBON

